





(1) Accoppiamento escavatore-attrezzatura ottimale / Optimum excavator-equipment combination  
 Couplage pelle-équipement optimal / Acoplamiento excavadora-implemento optimal  
 Optimale Bagger-Ausrüstung Kombination / Combinação máquina-implemento ideal

(2) Accoppiamento escavatore-attrezzatura possibile / Possible excavator-equipment combination  
 Couplage pelle-équipement possible / Acoplamiento excavadora-implemento posible  
 Mögliche Bagger-Ausrüstung Kombination / Combinação máquina-implemento possível



### Kit FR

		MK 07	MK 10	MK 13	MK 15	MK 20	MK 25	MK 35	MK 50	MK 70
<b>kg</b>	kg.	250	410	635	680	1035	1270	1720	2940	3940
A	mm.	530	660	720	740	880	905	970	1100	1300
B	mm.	510	610	630	660	790	820	860	1030	1130
C	mm.	175	195	235	300	310	360	390	440	500
D	mm.	305	355	390	465	485	570	640	720	770
	mm.	140	140	180	220	260	260	260	260	325
H2**	mm.	660	760	870	890	1045	1100	1210	1440	1580
X	t.	75	110	125	190	205	290	330	400	535
Y	t.	40	60	65	100	125	135	150	220	285
Z	t.	30	40	50	65	80	105	115	140	190
∅ max	mm.	20	25	30	35	40	45	50	60	75
 IPN max	mm.	/	/	/	/	/	/	/	/	/
 HEA max	mm.	/	/	/	/	/	/	/	/	/
 max	mm.	/	/	/	/	/	/	/	/	/

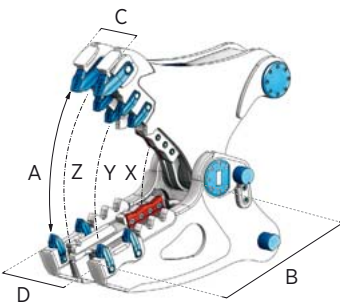

# FRANTUMATORE MULTI KIT

# Serie MK

MULTI KIT PULVERIZER

BROYEUR MULTI KIT

DEMOLEDOR MULTI KIT

MEHRZWECKGERÄT MULTI KIT

GARRA DEMOLIDORA MULTIFUNÇÕES

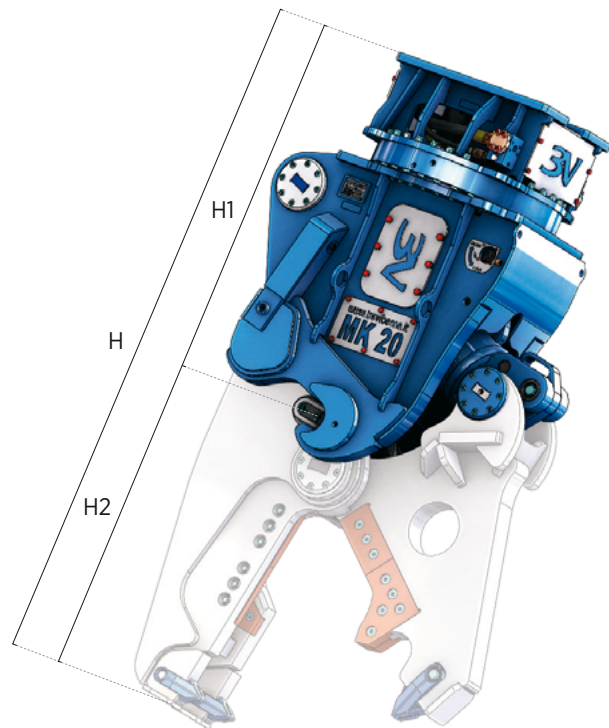

		MK 07*	MK 10*	MK 13*	MK 15	MK 20	MK 25	MK 35	MK 50	MK 70
	kg.	410	600	795	1180	1465	1970	2150	3420	5020
H1**	mm.	810	1000	1055	1220	1330	1370	1375	1540	1720
	bar	280	310	310	310	310	310	310	340	340
	l/min.	80 / 150	150 / 250	180 / 250	180 / 250	200 / 300	250 / 350	300 / 400	400 / 500	450 / 600
	bar	140	140	140	140	140	140	140	140	140
	l/min.	10	10	10	10	10	10	10	30	30
		/	/	/	/	/	/	/	√	√

(\*) Versione meccanica / (\*) Mechanical version / (\*) Version mécanique / (\*) Versión mecànica / (\*) Mechanischer Version / (\*) Versão mecânica  
 (\*\*) H = H1 + H2



		Kit CS								
		MK 07	MK 10	MK 13	MK 15	MK 20	MK 25	MK 35	MK 50	MK 70
	kg.	210	360	580	630	950	1240	1425	2290	2850
A	mm.	250	320	400	420	480	500	525	575	700
B	mm.	325	390	450	485	525	560	565	660	755
C	mm.	65	75	80	100	120	130	130	135	165
D	mm.	250	300	300	330	380	435	435	480	550
	mm.	310	370	410	470	510	565	565	660	755
H2**	mm.	545	630	725	775	890	935	990	1150	1300
X	t.	175	250	310	420	515	720	740	875	1100
Y	t.	70	100	120	155	235	290	315	385	470
Z	t.	40	60	75	85	125	145	160	205	240
∅ max	mm.	30	35	40	50	60	65	70	90	110
	mm.	80	120	140	210	360	380	400	500	600
	mm.	/	100	120	140	230	250	260	300	400
	mm.	/	/	/	/	/	/	/	/	/



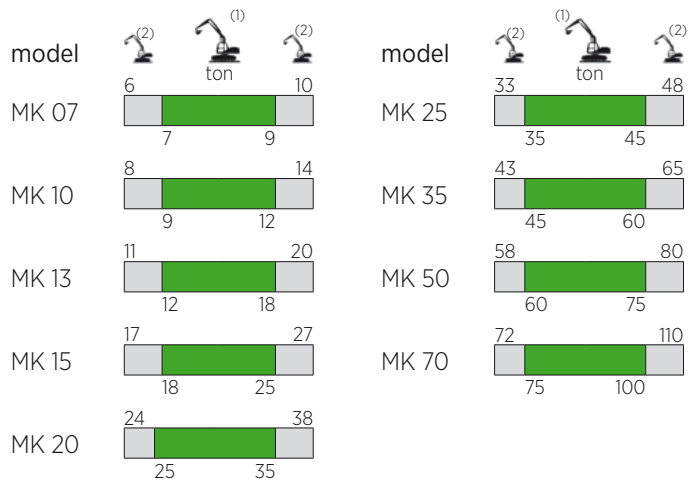

(1) Accoppiamento escavatore-attrezzatura ottimale / Optimum excavator-equipment combination  
 Couplage pelle-équipement optimal / Acoplamiento excavadora-implemento optimal  
 Optimale Bagger-Ausrüstung Kombination / Combinação máquina-implemento ideal

(2) Accoppiamento escavatore-attrezzatura possibile / Possible excavator-equipment combination  
 Couplage pelle-équipement possible / Acoplamiento excavadora-implemento posible  
 Mögliche Bagger-Ausrüstung Kombination / Combinação máquina-implemento possível



### Kit CB

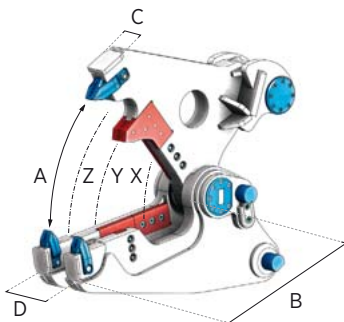

		MK 07	MK 10	MK 13	MK 15	MK 20	MK 25	MK 35	MK 50	MK 70
kg.		*	450	585	720	1090	1305	1780	2900	3890
A	mm.	*	580	640	740	810	850	910	990	1160
B	mm.	*	560	700	720	800	815	875	1065	1180
C	mm.	*	100	100	110	130	130	130	175	185
D	mm.	*	290	310	320	350	410	410	560	610
mm.		*	350	400	420	480	500	500	575	640
H2**	mm.	*	800	920	1000	1125	1155	1255	1490	1640
X	t.	*	220	270	420	510	700	740	900	1010
Y	t.	*	60	65	100	125	155	175	220	290
Z	t.	*	40	50	65	80	100	115	140	185
Ø max	mm.	*	30	35	40	45	50	55	70	85
IPN max	mm.	/	/	/	/	/	/	/	/	/
HEA max	mm.	/	/	/	/	/	/	/	/	/
max	mm.	/	/	/	/	/	/	/	/	/

(\*) Disponibile su richiesta / (\*) Available on request / (\*) Disponible sur demande / (\*) Disponible a petición / (\*) Verfügbar auf Anfrage  
 (\*) Disponível para pedido

# FRANTUMATORE MULTI KIT

# Serie MK

MULTI KIT PULVERIZER

BROYEUR MULTI KIT

DEMOLEDOR MULTI KIT

MEHRZWECKGERÄT MULTI KIT

GARRA DEMOLIDORA MULTIFUNÇÕES

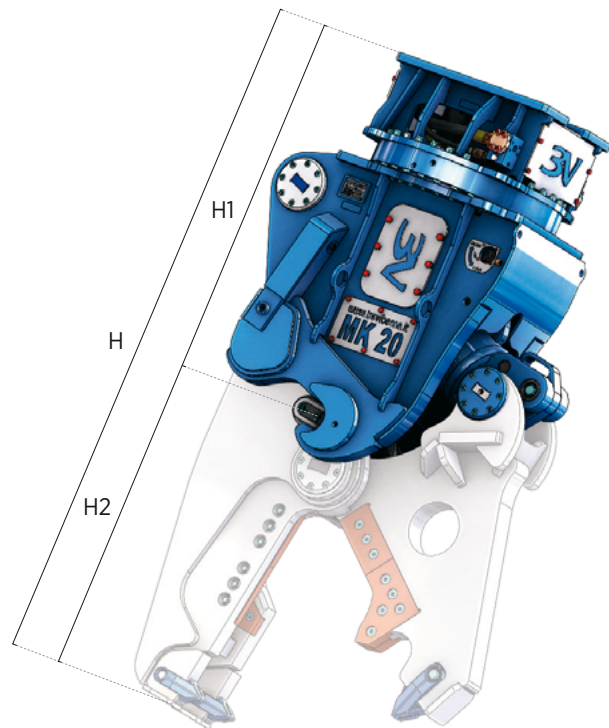

		MK 07*	MK 10*	MK 13*	MK 15	MK 20	MK 25	MK 35	MK 50	MK 70
	kg.	410	600	795	1180	1465	1970	2150	3420	5020
H1**	mm.	810	1000	1055	1220	1330	1370	1375	1540	1720
	bar	280	310	310	310	310	310	310	340	340
	l/min.	80 / 150	150 / 250	180 / 250	180 / 250	200 / 300	250 / 350	300 / 400	400 / 500	450 / 600
	bar	140	140	140	140	140	140	140	140	140
	l/min.	10	10	10	10	10	10	10	30	30
		/	/	/	/	/	/	/	√	√

(\*) Versione meccanica / (\*) Mechanical version / (\*) Version mécanique / (\*) Versión mecànica / (\*) Mechanischer Version / (\*) Versão mecânica  
 (\*\*) H = H1 + H2

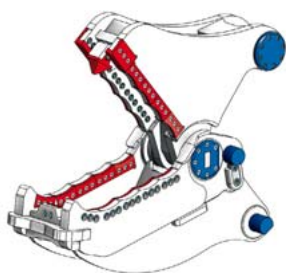

		Kit CH								
		MK 07	MK 10	MK 13	MK 15	MK 20	MK 25	MK 35	MK 50	MK 70
	kg.	*	*	610	740	1000	1300	1590	*	*
A	mm.	*	*	445	500	635	550	720	*	*
B	mm.	*	*	580	615	750	785	960	*	*
C	mm.	*	*	235	275	295	350	350	*	*
D	mm.	*	*	335	395	415	475	475	*	*
	mm.	*	*	530	530	660	600	750	*	*
H2**	mm.	*	*	900	910	1080	1100	1280	*	*
X	t.	*	*	245	260	375	720	740	*	*
Y	t.	*	*	105	115	150	215	220	*	*
Z	t.	*	*	60	80	100	130	135	*	*
∅ max	mm.	*	*	40	45	50	55	60	*	*
	mm.	/	/	/	/	/	/	/	/	/
	mm.	/	/	/	/	/	/	/	/	/
	mm.	/	/	/	/	/	/	/	/	/

(\*) Disponibile su richiesta / (\*) Available on request / (\*) Disponible sur demande / (\*) Disponible a petició / (\*) Verfügbar auf Anfrage  
 (\*\*) Disponível para pedido



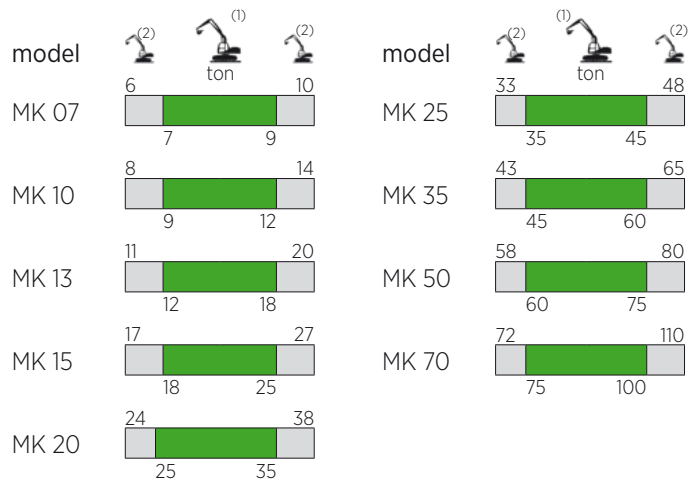

■ (1) Accoppiamento escavatore-attrezzatura ottimale / Optimum excavator-equipment combination  
 Couplage pelle-équipement optimal / Acoplamiento excavadora-implemento optimal  
 Optimale Bagger-Ausrüstung Kombination / Combinação máquina-implemento ideal

■ (2) Accoppiamento escavatore-attrezzatura possibile / Possible excavator-equipment combination  
 Couplage pelle-équipement possible / Acoplamiento excavadora-implemento posible  
 Mögliche Bagger-Ausrüstung Kombination / Combinação máquina-implemento possível



### Kit HC

		MK 07	MK 10	MK 13	MK 15	MK 20	MK 25	MK 35	MK 50	MK 70
	kg.	250	435	575	680	1075	1235	1700	2750	*
A	mm.	535	600	680	745	870	880	925	1010	*
B	mm.	490	610	710	740	765	815	875	1070	*
C	mm.	90	100	100	110	130	130	130	175	*
D	mm.	240	300	300	340	350	400	450	550	*
	mm.	125	150	200	175	240	250	250	290	*
H2**	mm.	690	810	925	1005	1125	1170	1275	1500	*
X	t.	100	135	165	220	290	350	385	465	*
Y	t.	45	60	75	90	130	150	180	220	*
Z	t.	30	40	50	65	85	105	115	140	*
∅ max	mm.	20	25	30	35	40	45	50	60	*
	IPN max	mm.	/	/	/	/	/	/	/	/
	HEA max	mm.	/	/	/	/	/	/	/	/
	max	mm.	/	/	/	/	/	/	/	/

(\*) Disponibile su richiesta / (\*) Available on request / (\*) Disponible sur demande / (\*) Disponible a petició / (\*) Verfügbar auf Anfrage  
 (\*) Disponível para pedido

# FRANTUMATORE MULTI KIT

# Serie MK

MULTI KIT PULVERIZER

BROYEUR MULTI KIT

DEMOLEDOR MULTI KIT

MEHRZWECKGERÄT MULTI KIT

GARRA DEMOLIDORA MULTIFUNÇÕES

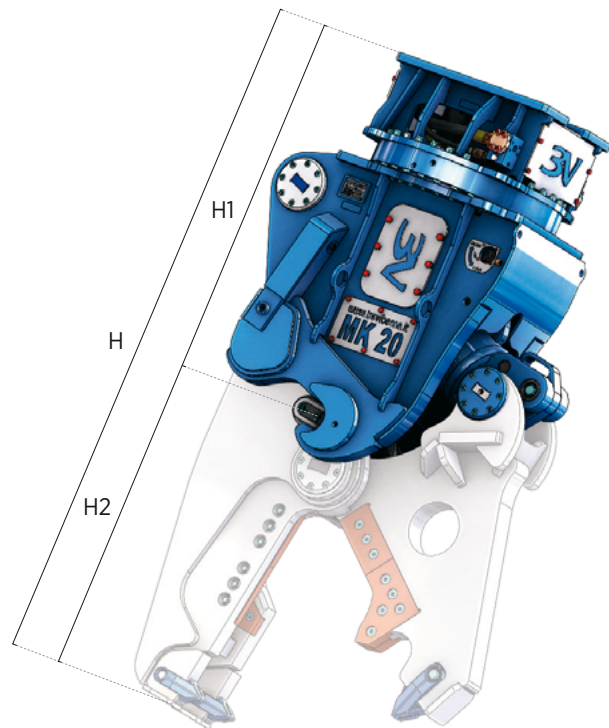

		MK 07*	MK 10*	MK 13*	MK 15	MK 20	MK 25	MK 35	MK 50	MK 70
	kg.	410	600	795	1180	1465	1970	2150	3420	5020
H1**	mm.	810	1000	1055	1220	1330	1370	1375	1540	1720
	bar	280	310	310	310	310	310	310	340	340
	l/min.	80 / 150	150 / 250	180 / 250	180 / 250	200 / 300	250 / 350	300 / 400	400 / 500	450 / 600
	bar	140	140	140	140	140	140	140	140	140
	l/min.	10	10	10	10	10	10	10	30	30
		/	/	/	/	/	/	/	√	√

(\*) Versione meccanica / (\*) Mechanical version / (\*) Version mécanique / (\*) Versión mecànica / (\*) Mechanischer Version / (\*) Versão mecânica  
 (\*\*) H = H1 + H2



		Kit CL								
		MK 07	MK 10	MK 13	MK 15	MK 20	MK 25	MK 35	MK 50	MK 70
	kg.	*	*	*	560	1000	1400	1750	*	*
A	mm.	*	*	*	270	350	370	400	*	*
B	mm.	*	*	*	360	465	520	780	*	*
C	mm.	*	*	*	115	145	150	160	*	*
D	mm.	*	*	*	310	390	440	480	*	*
	mm.	*	*	*	320	400	430	480	*	*
H2**	mm.	*	*	*	505	630	695	750	*	*
X	t.	*	*	*	220	270	320	350	*	*
Y	t.	*	*	*	150	200	225	230	*	*
Z	t.	/	/	/	110	140	160	170	*	*
∅ max	mm.	/	/	/	/	/	/	/	/	/
	mm.	/	/	/	/	/	/	/	/	/
	mm.	/	/	/	/	/	/	/	/	/
	mm.	*	*	*	10	12	14	16	*	*

(\*) Disponibile su richiesta / (\*) Available on request / (\*) Disponible sur demande / (\*) Disponible a petició / (\*) Verfügbar auf Anfrage  
 (\*\*) Disponível para pedido